



FEATURES

- Field-Bus remote data acquisition
- Modbus Slave device on RS-485
- Modbus RTU/ Modbus ASCII protocol
- 2 channel output
- Outputs configurable as Voltage or Current
- Watch-Dog Alarm
- Remotely Configurable
- 2000 Vac 3-ways Galvanic Isolation
- High Accuracy
- UL / CE mark
- DIN rail mounting in compliance with EN-50022



GENERAL DESCRIPTION

The DAT 3022 device generates 2 output analog signals from digital commands. The data are transmitted with MODBUS RTU/MODBUS ASCII protocol on the RS-485 network (RS-232 interface is available).

It is possible to generate voltage signals up to 10V and current signals up to 20mA, both active or passive loops.

The device guarantees high accuracy and stable measure versus time and temperature.

To ensure the plant safety, two Watch-Dog timer alarms are provided.

The isolation between the parts of circuit removes eventual ground-loop effects, allowing the use of the device even in the heavy environmental conditions.

The DAT 3022 is in compliance with the Directive UL 61010-1 for US market and with the Directive CSA C22.2 No 61010-1 for the Canadian market.

The device is housed in a rough self-extinguishing plastic container which, thanks to its thin profile of 17.5mm only, allows a high density mounting on EN-50022 standard DIN rail.

COMMUNICATION PROTOCOLS

The DAT3022 is designed to work with the MODBUS RTU/MODBUS ASCII protocol: standard protocol in field-bus; allows to directly interface DAT3000 series devices to the larger part of PLCs and SCADA applications available on the market.

For the protocol instructions, refer to the User Guide of the device.

USER INSTRUCTIONS

Before to install the device, please read the "Installation Instruction" section.

If the module configuration is unknown, with device powered off, connect the INIT terminal to the GND terminal (ground), at the next power on the device will be auto-configured in the default settings (refer to the User Guide of the device).

Connect power supply, serial bus and analogue outputs as shown in the "Wiring" section.

The "PWR" LED state depends on the working condition of the device: see the "Light Signalling" section to verify the device working state.

To perform configuration and calibration operations, read the instructions in the User Guide of the device.

To simplify handling or replacing of the device, it is possible to remove the wired terminals even with the device powered.

TECHNICAL SPECIFICATIONS (Typical @ 25 °C and in the nominal conditions)

OUTPUT (2 channels)			Output Accuracy		POWER SUPPLY	
Output type	Min	Max				
Current mA	0 mA	+20 mA	Current	± 20 µA	Power supply voltage	18 .. 30 Vdc
Voltage Volt	0 V	+10 V	Voltage	± 10 mV	Reverse polarity protection	60 Vdc max
			Thermal drift		Current consumption	60 mA max.
			Full scale	± 0.01 % / °C	ISOLATION	
			Load resistance		On all the ways	2000 Vac, 50 Hz, 1 min
			Voltage	≥ 5 KΩ	ENVIRONMENTAL CONDITIONS	
			Current	≤ 500 Ω	Operative Temperature	-10°C .. +60°C
			Auxiliary Voltage (2 channels)		UL Operative Temperature	-10°C .. +40°C
			> 12V @ 20mA		Storage Temperature	-40°C.. +85°C
			Response time		Humidity (not condensed)	0 .. 90 %
			Slew-rate analogue output		Maximum Altitude	2000 m
			(with dedicated setting for each channel)		Installation	Indoor
					Category of installation	II
					Pollution Degree	2
					MECHANICAL SPECIFICATIONS	
					Material	Self-extinguish plastic
					IP Code	IP20
					Wiring	wires with diameter 0.8+2.1 mm ² /AWG 14-18
					Tightening Torque	0.5 N m
					Mounting	in compliance with DIN rail standard EN-50022
					Weight	about 150 g.
					CERTIFICATIONS	
					EMC (for industrial environments)	
					Immunity	EN 61000-6-2
					Emission	EN 61000-6-4
					UL	
					US Standard	UL 61010-1
					Canadian Standard	CSA C22.2 No 61010-1
					CCN	NRAQ/NRAQ7
					Typology	Open Type device
					Classification	Industrial Control Equipment
					File Number	E352854
			Data Transmission			
			Baud Rate	115.2 Kbps		
			Max. distance	1.2 Km – 4000 ft		

INSTALLATION INSTRUCTIONS

The DAT 3022 is suitable for fitting to DIN rails in the vertical position. For optimum operation and long life follow these instructions:

When the devices are installed side by side it may be necessary to separate them by at least 5 mm in the following case:

- If panel temperature exceeds 45°C and at least one of the overload conditions exist.
- If panel temperature exceeds 35°C and at least two of the overload conditions exist.

The overload conditions are the following:

- High supply voltage: >27Vdc
- Use of the auxiliary power supply

Make sure that sufficient air flow is provided for the device avoiding to place raceways or other objects which could obstruct the ventilation slits. Moreover it is suggested to avoid that devices are mounted above appliances generating heat; their ideal place should be in the lower part of the panel.

Install the device in a place without vibrations.

Moreover it is suggested to avoid routing conductors near power signal cables (motors, induction ovens, inverters etc...) and to use shielded cable for connecting signals.

CABLING

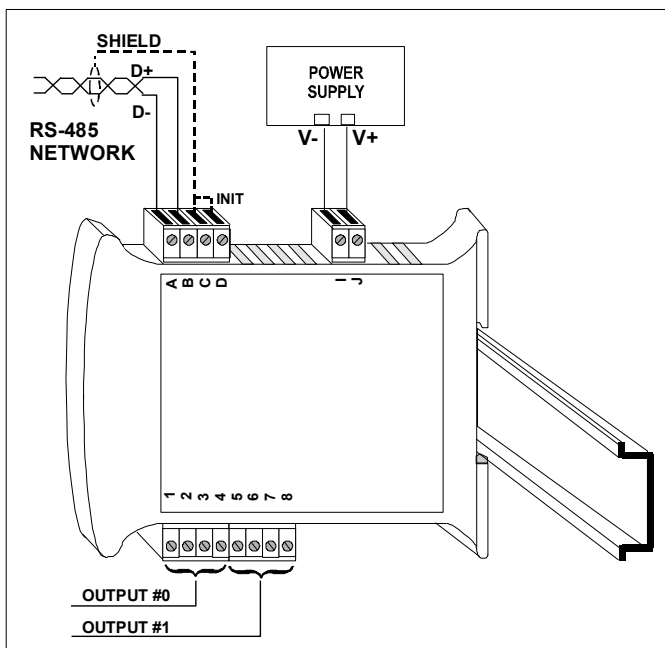

LIGHT SIGNALLING

LED	COLOUR	STATE	DESCRIPTION
PWR	GREEN	ON	Device powered
		OFF	Device not powered / Wrong RS-485 cabling.
		FAST BLINK	Communication in progress (blink frequency depends to baud-rate)
		1 second BLINK	Watch-Dog Alarm condition

MECHANICAL DIMENSIONS (mm)

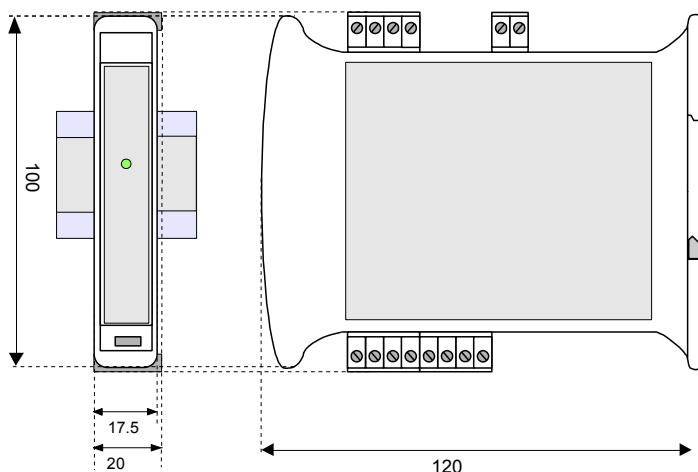

WIRING

ANALOGUE OUTPUTS

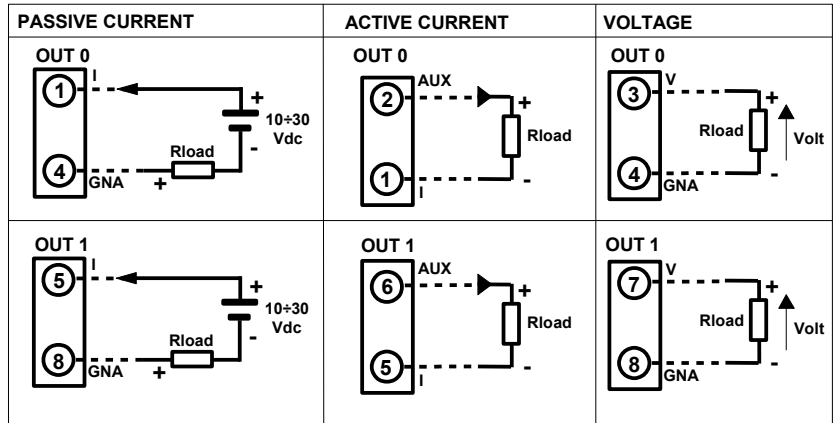

Note: the output channels are not isolated between them.
Terminals AUX of channels connected between them.
Terminals GNA of channels connected between them

RS-485 NETWORK

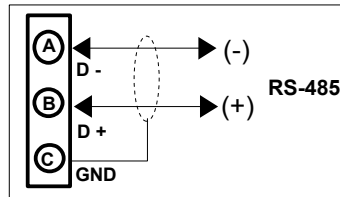

RS-232 NETWORK

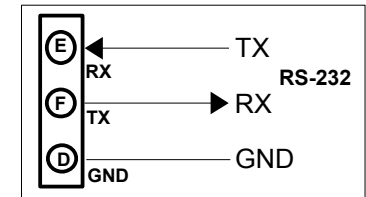

POWER SUPPLY (*)

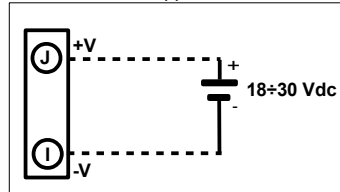

INIT(**)

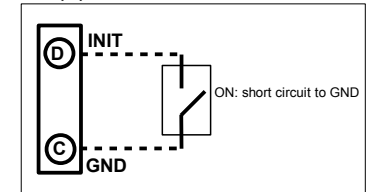

(*) Note: for UL installation the device must be powered using a power supply unit classified NEC class 2 or SELV

(**) Note: for RS232 version INIT and GND are inverted between them

ISOLATION STRUCTURE



HOW TO ORDER

In the order phase, it is mandatory to specify the interface type (RS485 or RS232). DAT3022 can be supplied with the configuration specified by the customer.

ORDER CODE:

DAT 3022 / 485 / mA

Interface type
485 : RS-485
232 : RS-232

Output type

■ = Requested
□ = Optional

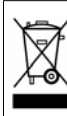

The symbol reported on the product indicates that the product itself must not be considered as a domestic waste. It must be brought to the authorized recycle plant for the recycling of electrical and electronic waste. For more information contact the proper office in the user's city, the service for the waste treatment or the supplier from which the product has been purchased.