

2 / 3-Phase SSR with Detachable / Integrated Heatsink

SR2 / SR3 / SRH2 / SRH3 Series

INSTRUCTION MANUAL

TCD210095AA

Autonics

Thank you for choosing our Autonics product.

Read and understand the instruction manual and manual thoroughly before using the product.

For your safety, read and follow the below safety considerations before using.

For your safety, read and follow the considerations written in the instruction manual, other manuals and Autonics website.

Keep this instruction manual in a place where you can find easily.

The specifications, dimensions, etc. are subject to change without notice for product improvement. Some models may be discontinued without notice.

Follow Autonics website for the latest information.

Safety Considerations

- Observe all 'Safety Considerations' for safe and proper operation to avoid hazards.
- ⚠ symbol indicates caution due to special circumstances in which hazards may occur.

⚠ Warning Failure to follow instructions may result in serious injury or death.

01. Fail-safe device must be installed when using the unit with machinery that may cause serious injury or substantial economic loss. (e.g., nuclear power control, medical equipment, ships, vehicles, railways, aircraft, combustion apparatus, safety equipment, crime/disaster prevention devices, etc.) Failure to follow this instruction may result in personal injury, economic loss or fire.

02. Do not use the unit in the place where flammable/explosive/corrosive gas, high humidity, direct sunlight, radiant heat, vibration, impact or salinity may be present. Failure to follow this instruction may result in explosion or fire.

03. Install the unit on DIN rail or panel to use. Failure to follow this instruction may result in fire or electric shock.

04. Do not connect, repair, or inspect the unit while connected to a power source. Failure to follow this instruction may result in fire or electric shock.

05. Check 'Connections' before wiring. Failure to follow this instruction may result in fire.

06. Do not disassemble or modify the unit. Failure to follow this instruction may result in fire or electric shock.

⚠ Caution Failure to follow instructions may result in injury or product damage.

01. Use the unit within the rated specifications. Failure to follow this instruction may result in fire or product damage.

02. Use a dry cloth to clean the unit, and do not use water or organic solvent. Failure to follow this instruction may result in fire or electric shock.

03. Keep the product away from metal chip, dust, and wire residue which flow into the unit. Failure to follow this instruction may result in fire or product damage.

04. Since leakage current still flows right after turning off the power or in the output OFF status, do not touch the load terminal. Failure to follow this instruction may result in electric shock.

Cautions during Use

- Follow instructions in 'Cautions during Use'. Otherwise, it may cause unexpected accidents.
- 4 - 30 VDC \approx , 24 VAC \sim model supply should be insulated and limited voltage/current or Class 2, SELV power supply device.
- Attach a heat sink or install the unit in the well ventilated place. To attach the heat sink, use Thermal Grease as below or that of equal specification.
 - Thermal Grease
 - GE TOSHIBA (YG6111), KANTO-KASEI (FLOIL G-600), SHINETSU (G746)
- Ground the heatsink, panel, or DIN rail. Failure to follow this instruction may result in electric shock.
- While supplying power to the load or right after turning off the power of the load, do not touch the body and heat sink. Failure to follow this instruction may result in burn due to high temperature of the surface.
- In order to protect the product from the short-circuit current of the load, use rapid fuse of which I²t is under the 1/2 of SSR I²t. When short-circuited, replace the fuse to those of same specification with the used rapid fuse.
- Install dummy resistance in parallel with the load, to keep the sum of current flowing in the load and dummy resistance being over SSR minimum load current.
- When using random turn-on model for phase control, install noise filter between the load and the power of the load.
- Do not use near the equipment which generates strong magnetic force or high frequency noise.
- This unit may be used in the following environments.
 - Indoors (in the environment condition rated in 'Specifications')
 - Altitude max. 2,000 m
 - Pollution degree 2
 - Installation category III

Ordering Information

This is only for reference, the actual product does not support all combinations. For selecting the specified model, follow the Autonics website.

SR ① ② - ③ ④ ⑤ ⑥

① Type

No mark: detachable heatsink
H: Integrated heatsink

② Number of the control phase

2: 2-phase
3: 3-phase

③ Rated input voltage

1: 4 - 30 VDC \approx
2: 24 VAC \sim
4: 90 - 240 VAC \sim

④ Rated load voltage

2: 24 - 240 VAC \sim
4: 48 - 480 VAC \sim

⑤ Rated load current (resistive load)

Number: rated load current (unit: A)

⑥ Function

No mark: Zero cross turn-on
R: Random turn-on

Product Components

- Product
- Instruction manual

Dimensions

Unit: mm, For the detailed drawings, follow the Autonics website.

A	B
Input indicator (green)	Alarm indicator (red)

When installing to the panel, tightening the detachable heatsink type screw with a torque of 2.5 to 3 N m, in case of the integrated heatsink type screw, the tightening torque with 1.35 N m.

■ Detachable heatsink type

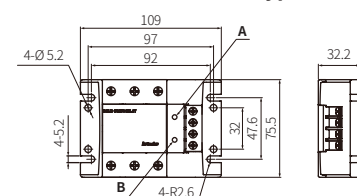

■ Integrated heatsink type

Rated load current 15 / 30 / 40 A

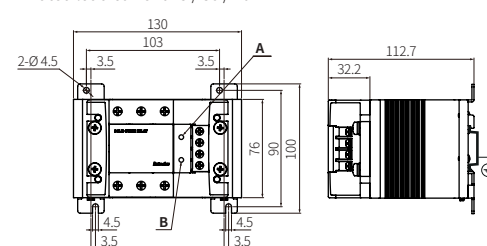

Rated load current 50 A

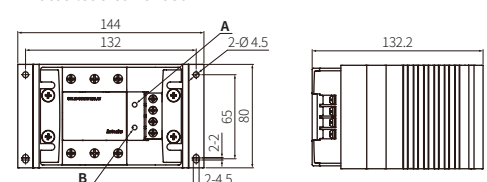

Rated load current 75 A

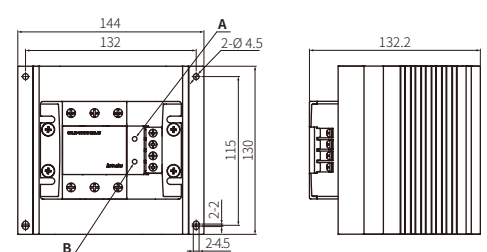

■ Panel cut-out

Detachable heatsink type

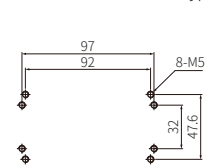

Integrated heatsink type (rated load current 50 A)

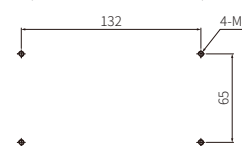

Integrated heatsink type (rated load current 15 / 30 / 40 A)

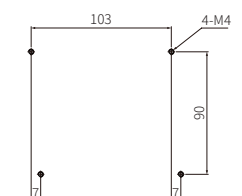

Integrated heatsink type (rated load current 75 A)

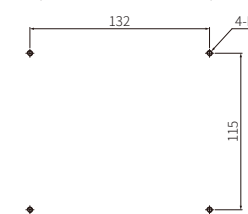

■ Cooling fan mounting hole

Rated load current 30 / 40 A

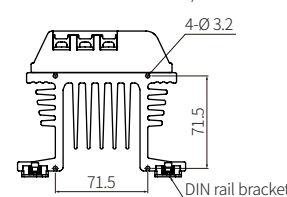

Rated load current 50 / 75 A

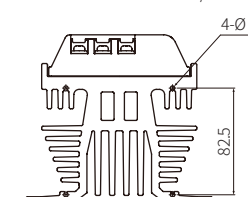

Cautions during Installation

⚠ Caution High Temperature

While supplying power to the load or right after turning off the power of the load, do not touch the body and heat sink. Failure to follow this instruction may result in burn due to high temperature of the surface.

■ Spacing

- When installing multiple SSRs, be sure to keep space between SSRs for heat radiation.
- When installing SSRs horizontally (input part and output part on the same height), be sure to supply less than 50 % of the rated load current.

■ Specifications of cooling fan

Autonics does not provide or sell a cooling fan. Buy directly a cooling fan.

Load capacity	Cooling fan type	Size	Rated air flow ⁽⁰¹⁾	
			m ³ /min	CFM
30 / 40 A	AC Fan	80 × 80 mm	0.68	24.0
	DC Fan		1.25	44.0
50 / 75 A	AC Fan	92 × 92 mm	1.13	40.0
	DC Fan		1.80	63.5

(01) The cooling fan should be over the rated air flow value.

■ Grounding

- Be sure to ground the bolts for grounding.

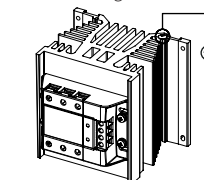

Connections

- For DC signal input models, 8 and 10 terminals are connected inside.
- For AC signal input models, 8 and 10 terminals are insulated inside.

■ 2-phase

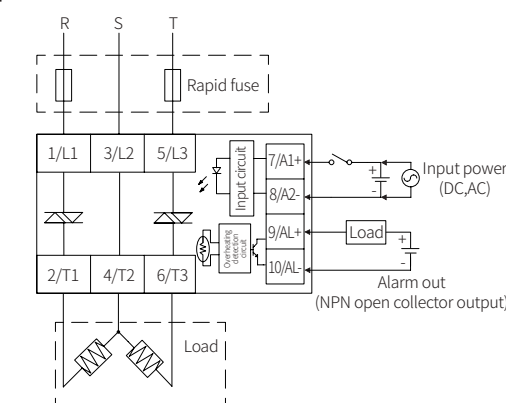

■ 3-phase

- Delta connection (Δ connection)

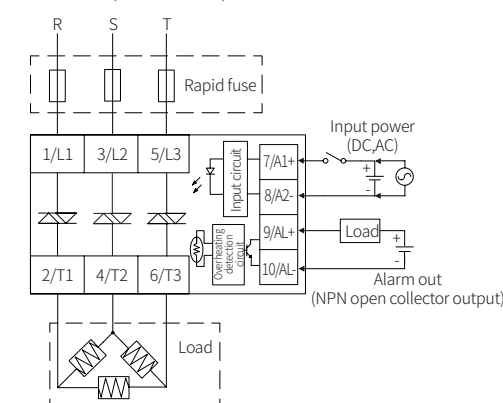

- Star connection (Y connection)

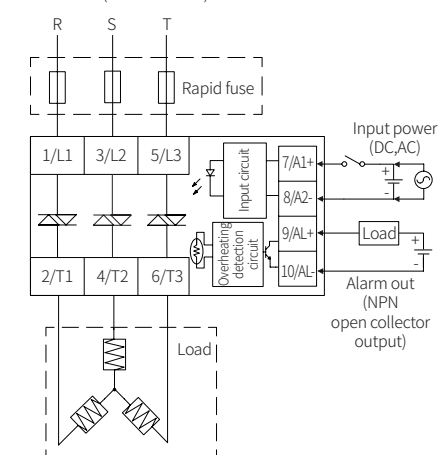

Cautions for Wiring

- Unit: mm, When connecting the wire to the terminal, use the round crimp terminal.

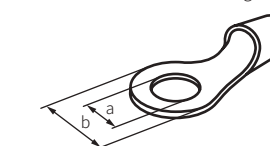

Size	Input	Output
a	≥ 3.5 mm	≥ 5.0 mm
b	≤ 7.0 mm	≤ 12.0 mm

Specifications

Input

Rated input voltage range	4 - 30 VDC≡	240 VACrms~ (50/60 Hz)	90 - 240 VACrms~ (50/60 Hz)
Allowable input voltage range	4 - 32 VDC≡	19 - 26.4 VACrms~ (50/60 Hz)	85 - 264 VACrms~ (50/60 Hz)
Max. input current	25 mA	15 mA	25 mA
Operating voltage	≥ 4 VDC≡	≥ 19 VACrms~	≥ 85 VACrms~
Releasing voltage	≤ 1 VDC≡	≤ 4 VACrms~	≤ 10 VACrms~
Operating time	Zero cross turn-on	≤ 0.5 cycle of load power + 1 ms	≤ 1.5 cycle of load power + 1 ms
	Random turn-on	≤ 1 ms	-
Releasing time	Zero cross turn-on	≤ 0.5 cycle of load power + 1 ms	≤ 1.5 cycle of load power + 1 ms
	Random turn-on	≤ 1 ms	-

Output

Rated load voltage range	24 - 240 VACrms~ (50/60 Hz)			
Allowable load voltage range	24 - 264 VACrms~ (50/60 Hz)			
Rated load current	Resistive load (AC-51) ⁰¹⁾			
	15 Arms	30 Arms	50 Arms	75 Arms
Min. load current	0.15 Arms	0.2 Arms	0.5 Arms	0.5 Arms
Max. 1 cycle surge current (60 Hz)	250 A	400 A	1000 A	1000 A
Max. non-repetitive surge current (I ² t, t = 8.3 ms)	340 A ² s	1000 A ² s	4000 A ² s	4000 A ² s
Peak voltage (non-repetitive)	600 V			
Leakage current (Ta = 25 °C)	≤ 10 mA Arms (240 VAC~/60 Hz)			
Output ON voltage drop [Vpk] (max. load current)	≤ 1.6 V			
Static off state dv/dt	500 V/μs			

Rated load voltage range	48 - 480 VACrms~ (50/60 Hz)				
Allowable load voltage range	48 - 528 VACrms~ (50/60 Hz)				
Rated load current	Resistive load (AC-51) ⁰¹⁾				
	15 Arms	30 Arms	40 Arms	50 Arms	75 Arms
Min. load current	0.5 Arms				
Max. 1 cycle surge current (60 Hz)	300 A	500 A	500 A	1000 A	1000 A
Max. non-repetitive surge current (I ² t, t = 8.3 ms)	350 A ² s	1000 A ² s	1000 A ² s	4000 A ² s	4000 A ² s
Peak voltage (non-repetitive)	1200 V (zero cross turn-on), 1000 A (random turn-on)				
Leakage current (Ta = 25 °C)	≤ 10 mA Arms (480 VAC~/60 Hz)				
Output ON voltage drop [Vpk] (max. load current)	≤ 1.6 V				
Static off state dv/dt	500 V/μs				

01) AC-51 is utilization category at IEC60947-4-3.

Alarm output (overheat prevention function)

Rated input voltage range	4 - 30 VDC≡	24 VACrms~ (50/60 Hz)	90 - 240 VACrms~ (50/60 Hz)
Load voltage	≤ 30 VDC≡	≤ 30 VDC≡	≤ 30 VDC≡
Load current	≤ 100 mA	≤ 50 mA	≤ 50 mA
Turn-off time	≤ 20 ms	≤ 40 ms	≤ 40 ms

• Overheat prevention function is when SSR internal temperature is overheated, the load output is cut off to prevent internal device damage and also the alarm indicator and alarm output turn ON.

General specifications

Dielectric strength (Vrms) : 24-240 VAC~	Rated load current 15 / 30 A : 2500 VAC~ 50/60 Hz for 1 min (input-output, input/output-case) Rated load current 50 / 75 A : 4000 VAC~ 50/60 Hz for 1 min (input-output, input/output-case)
Dielectric strength (Vrms) : 48-480 VAC~	4000 VAC~ ~ 50/60 Hz for 1 min (input-output, input/output-case)
Insulation resistance	≥ 100 MΩ (500 VDC≡ megger) (input-output, input/output-case)
Indicator	Input indicator (green), alarm indicator (red)
Vibration	0.75 mm double amplitude at frequency of 10 to 55 Hz (for 1 min) in each X, Y, Z direction for 1 hour
Vibration (malfunction)	0.5 mm double amplitude at frequency of 10 to 55 Hz (for 1 min) in each X, Y, Z direction for 10 min
Shock	300 m/s ² (≈ 30 G) in each X, Y, Z direction for 3 times
Shock (malfunction)	100 m/s ² (≈ 10 G) in each X, Y, Z direction for 3 times
Ambient temperature⁰¹⁾	-30 to 80 °C (in case of the rated input voltage 90 - 240 VAC~. -30 to 70 °C), storage: -30 to 100 °C (no freezing or condensation)
Ambient humidity	45 to 85%RH, storage: 45 to 85%RH (no freezing or condensation)
Input terminal connection / alarm output terminal connection	≥ 1 × 0.5 mm ² (1 × AWG 20), ≥ 1 × 1.5 mm ² (1 × AWG 16) or ≤ 2 × 1.5 mm ² (2 × AWG 16)
Output terminal connection⁰²⁾	≥ 1 × 1.5 mm ² (1 × AWG 16), ≥ 1 × 1.6 mm ² (1 × AWG 6) or ≤ 2 × 6 mm ² (2 × AWG 10)
Input terminal fixed torque	0.75 to 0.95 N m
Output terminal fixed torque	1.6 to 2.2 N m
Approval	CE, RoHS, ENEC

01) Refer to the 'SSR Derating Curve' in the product manual because the capacity of the rated load current is differ depending on the ambient temperature.

02) Connect the wire met the capacity of the load current to the output terminal.

	Weight (packaged)	
Detachable heatsink type	≈ 275 g (≈ 365 g)	
Integrated heatsink type	15 / 30 / 40 A	≈ 686 g (≈ 896 g)
	50 A	≈ 1268 g (≈ 1508 g)
	75 A	≈ 2064 g (≈ 2354 g)

SSR Derating Curve

- The heatsink of the curves is dedicated for the SRH2/SRH3.
- Install SR2 / SR3 Series on the metal plate (min. 130 × 120 mm).
- Be aware that the ambient temperature and the derating curve is different by the rated input voltage when using the product.
- ⚠ When installing multiple SSRs, be sure to keep space between SSRs for heat radiation. When installing SSRs horizontally (input part and output part on the same height), be sure to supply less than 50 % of the rated load current.
- SSR derating curves obtained approval from the UL certification authority.

SR(H)2 / SR(H)3-1215

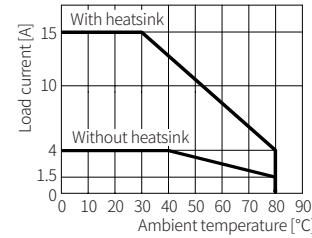

SR(H)2 / SR(H)3-4215

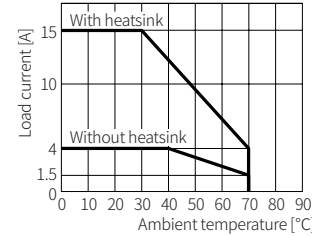

SR(H)2 / SR(H)3-1230

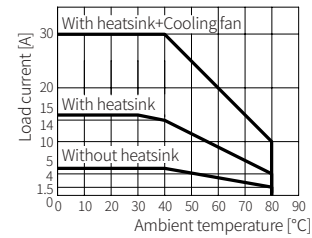

SR(H)2 / SR(H)3-4230

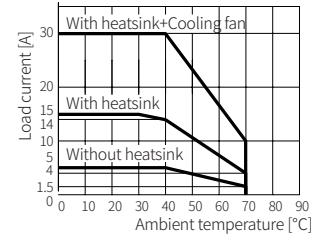

SR(H)2 / SR(H)3-1415 / 1415R / 2415

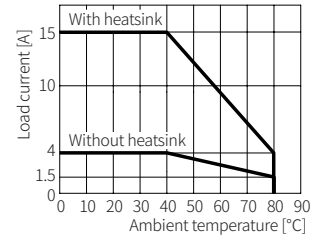

SR(H)2 / SR(H)3-4415

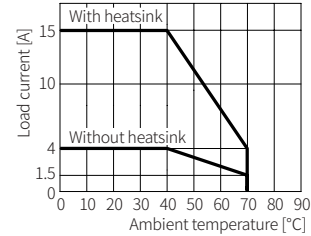

SR(H)2 / SR(H)3-1430 / 1430R / 2430

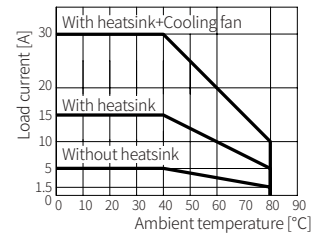

SR(H)2 / SR(H)3-4430

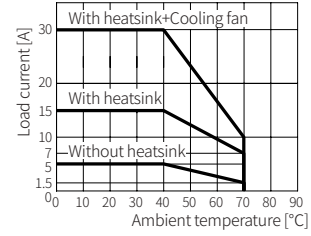

SR(H)2 / SR(H)3-1440 / 1440R / 2440

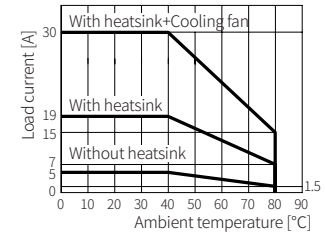

SR(H)2 / SR(H)3-1250 / 1450 / 1450R / 2450

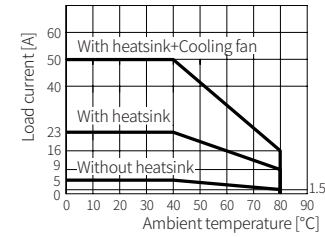

SR(H)2 / SR(H)3-4275 / 4475

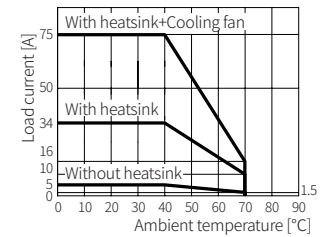

SR(H)2 / SR(H)3-4440

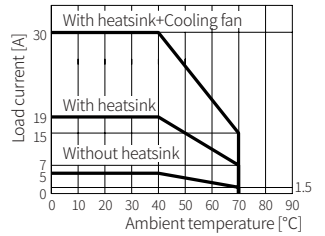

SR(H)2 / SR(H)3-4250 / 4450

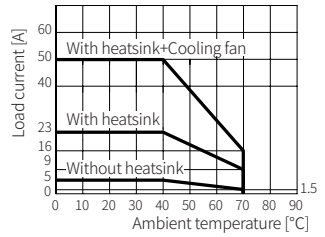

SR(H)2 / SR(H)3-1275 / 1475 / 1475R / 2475

