



FEATURES

- Field-Bus remote data acquisition
- Modbus Slave device on RS-485
- Modbus RTU/ Modbus ASCII protocol
- 4 channels input up to $\pm 20\text{ mA}$
- Watch-Dog Alarm
- Remotely Configurable
- 2000 Vac 3-ways Galvanic Isolation
- High Accuracy
- UL / CE mark
- DIN rail mounting in compliance with EN-50022

GENERAL DESCRIPTION

The device DAT 3015-I is able to acquire up to 4 analogue input signals. The data are transmitted with MODBUS RTU/MODBUS ASCII protocol on the RS-485 network (RS-232 interface is available).

It is possible to connect on input current signals up to $\pm 20\text{ mA}$.

The device guarantees high accuracy and stable measure versus time and temperature.

To ensure the plant safety, two Watch-Dog timer alarms are provided.

The isolation between the parts of circuit removes eventual ground-loop effects, allowing the use of the device even in the heavy environmental conditions.

The DAT 3015-I is in compliance with the Directive UL 61010-1 for US market and with the Directive CSA C22.2 No 61010-1 for the Canadian market.

The device is housed in a rough self-extinguishing plastic container which, thanks to its thin profile of 17.5mm only, allows a high density mounting on EN-50022 standard DIN rail.

COMMUNICATION PROTOCOLS

The DAT 3015-I is designed to work with the MODBUS RTU/MODBUS ASCII protocol: standard protocol in field-bus; allows to directly interface DAT3000 series devices to the larger part of PLCs and SCADA applications available on the market.

For the protocol instructions, refer to the User Guide of the device.

USER INSTRUCTIONS

Before to install the device, please read the "Installation Instruction" section.

If the module configuration is unknown, with device powered off, connect the INIT terminal to the GND terminal (ground), at the next power on the device will be auto-configured in the default settings (refer to the User Guide of the device).

Connect power supply, serial bus and analogue inputs as shown in the "Wiring" section.

The "PWR" LED state depends on the working condition of the device: see the "Light Signalling" section to verify the device working state.

To perform configuration and calibration operations, read the instructions in the User Guide of the device.

To simplify handling or replacing of the device, it is possible to remove the wired terminals even with the device powered.

TECHNICAL SPECIFICATIONS (Typical @ 25 °C and in the nominal conditions)

INPUT			Input Accuracy (1) Current	$\pm 20\text{ uA}$	POWER SUPPLY Power supply voltage	10 .. 30 Vdc	
Input type	Min	Max					
Current			Linearity (1) Current	$\pm 0.1\% \text{ f.s.}$	Reverse polarity protection	60 Vdc max	
20 mA	-20 mA	+20mA					
			Input Impedance Current	$\leq 22\ \Omega$	CURRENT CONSUMPTION		
					Thermal drift (1) Full scale	$\pm 0.005\% / ^\circ\text{C}$	ISOLATION
			Sample time	0.5 + 1 sec.			Input – RS485
					Data Transmission Baud Rate	38.4 Kbps	Supply – Input
			Max. distance	1.2 Km – 4000 ft			Supply – RS485
					ENVIRONMENTAL CONDITIONS		
			Operative Temperature				-10°C .. +60°C
			UL Operative Temperature				-10°C .. +40°C
			Storage Temperature				-40°C.. +85°C
			Humidity (not condensed)				0 .. 90 %
			Maximum Altitude				2000 m
			Installation				Indoor
			Category of installation				II
			Pollution Degree				2
			MECHANICAL SPECIFICATIONS				
			Material				Self-extinguish plastic
			IP Code				IP20
			Wiring				wires with diameter
							0.8+2.1 mm ² /AWG 14-18
			Tightening Torque				0.5 N m
			Mounting				in compliance with DIN rail
							standard EN-50022
			Weight				about 150 g.
			CERTIFICATIONS				
			EMC (for industrial environments)				
			Immunity				EN 61000-6-2
			Emission				EN 61000-6-4
			UL				
			US Standard				UL 61010-1
			Canadian Standard				CSA C22.2 No 61010-1
			CCN				NRAQ/NRAQ7
			Typology				Open Type device
			Classification				Industrial Control
							Equipment
			File Number				E352854

(1) Referred to input Span (difference between max. and min. values)

INSTALLATION INSTRUCTIONS

The DAT 3015-I is suitable for fitting to DIN rails in the vertical position. For optimum operation and long life follow these instructions:

When the devices are installed side by side it may be necessary to separate them by at least 5 mm in the following case:

- If panel temperature exceeds 45°C and at least one of the overload conditions exist.

Make sure that sufficient air flow is provided for the device avoiding to place raceways or other objects which could obstruct the ventilation slits. Moreover it is suggested to avoid that devices are mounted above appliances generating heat; their ideal place should be in the lower part of the panel. Install the device in a place without vibrations.

Moreover it is suggested to avoid routing conductors near power signal cables (motors, induction ovens, inverters etc...) and to use shielded cable for connecting signals.

CABLING

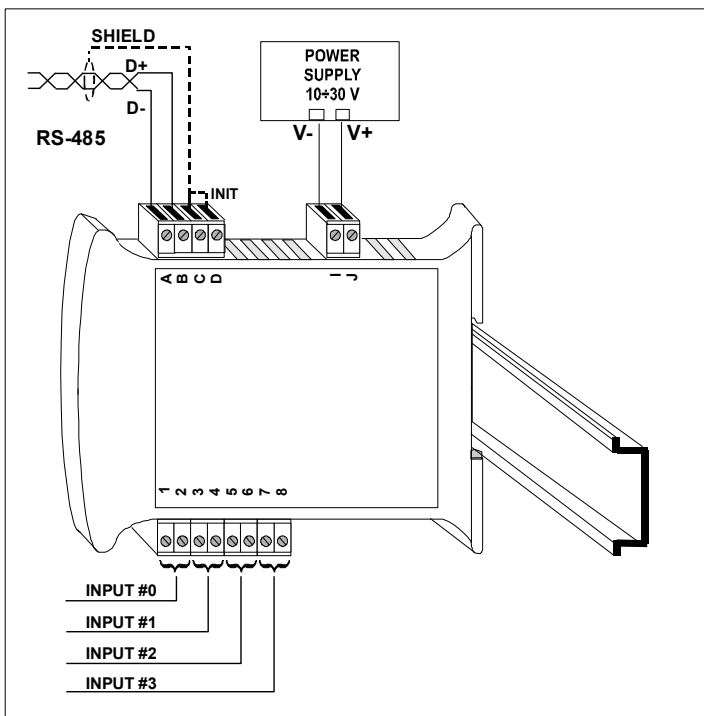

LIGHT SIGNALLING

LED	COLOUR	STATE	DESCRIPTION
PWR	GREEN	ON	Device powered
		OFF	Device not powered / Wrong RS-485 cabling.
		FAST BLINK	Communication in progress (blink frequency depends to baud-rate)
		1 second BLINK	Watch-Dog Alarm condition

MECHANICAL DIMENSIONS (mm)

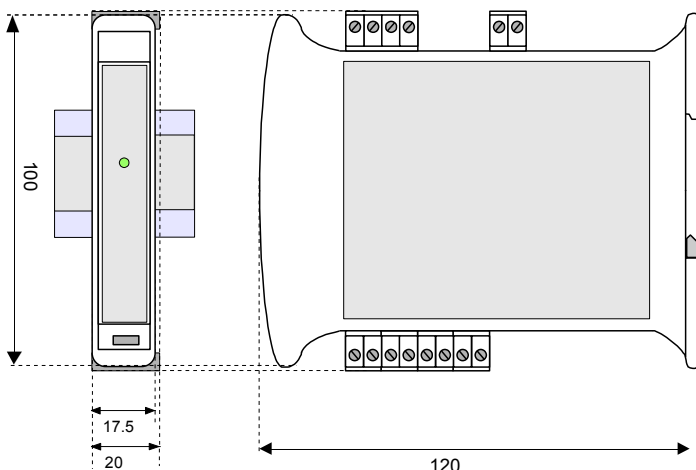

WIRING

ANALOG INPUT

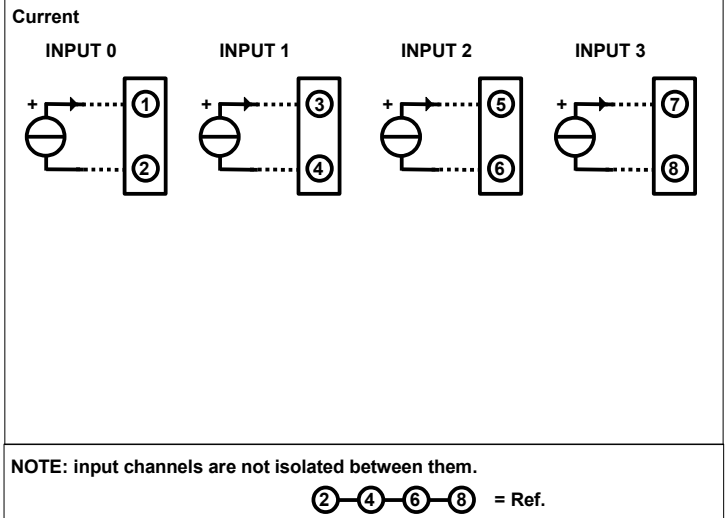

RS-485 NETWORK

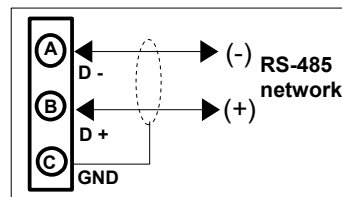

RS-232 NETWORK

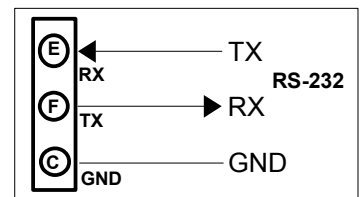

POWER SUPPLY (*)

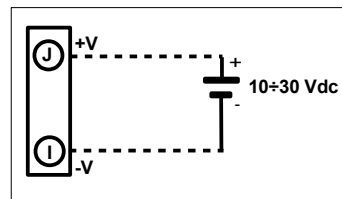

INIT

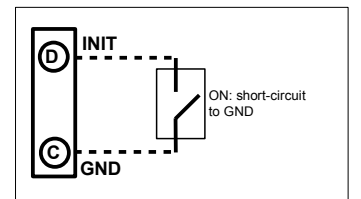

(*) Note: for UL installation the device must be powered using a power supply unit classified NEC class 2 or SELV

ISOLATION STRUCTURE



HOW TO ORDER

In the order phase, it is mandatory to specify the interface type (RS485 or RS232).

ORDER CODE:

DAT 3015-I / 485

Interface type
485 : RS-485
232 : RS-232

■ = Requested
□ = Optional