

## DeviceNet Analog Remote I/O

NEW

### ■ Features

- Adopts DeviceNet, standard open Network
  - : Communicates other DeviceNet devices without additional installations
  - : Configurable power and communication system only with communication cables
  - : Connectable max. 63 units per 1 master unit
- Strong against noise and high accuracy(0.3%) measurement with differential input method(measuring difference between +, - input signal)
- Various I/O range: 0-5VDC, 1-5VDC, 0-10VDC, -5-5VDC, -10-10VDC, DC4-20mA, DC0-20mA
- Scale function: Settable high/low limit scale value for analog I/O range (Set range: -28,000 to 28,000)
- Various functions
  - : Automatic communication speed recognition, Network voltage monitoring, Input digital filter, Peak/Bottom Hold, hysteresis, reading model name and number of units, I/O and status flag monitoring
- Built-in surge, ESD protection, Reverse polarity protection circuit
- Mounting DIN rail method and screw lock method



**!** Please read "Caution for your safety" in operation manual before using.



### ■ Ordering information

<b>AR</b>	<b>D</b>	<b>A</b>	<b>I</b>	<b>04</b>	
				I/O points	04
				I/O type	I
				Digital/Analog	O
				Network	A
				Item	D <sup>※1</sup>
					D
					AR

04	4-point type
I	Input type
O	Output type
A	Analog type
D <sup>※1</sup>	Digital type
D	DeviceNet type
AR	Autonics Remote I/O

※1. For digital type ARD-D Series, refer to the S-5 page.

### ■ Specifications

Model	ARD-AI04	ARD-AO04
Power supply	Rated voltage: 24 VDC, Voltage range: 12-28 VDC	
Power consumption	Max. 3 W	
Insulation type	Photocoupler isolated	
I/O points	Input 4-point (switchable voltage/current)	Output 4-point (voltage 2CH, current 2CH)
Control I/O	Voltage	0-10 VDC, -10-10 VDC, 0-5 VDC, 1-5 VDC, -5-5 VDC (input impedance: max. 1 MΩ)
	Current	DC4-20 mA, DC0-20mA (input impedance: 250Ω)
Max. allowable I/O	±5% F.S of rated I/O range	
Sampling cycle	1 ms/point	
Accuracy	25±5 °C	±0.3% F.S
	-10 ±20 °C	±0.6% F.S.
	30 to 50 °C	
Resolution	1/16,000	
Insulation resistance	Min. 200 MΩ(at 500 VDC megger)	
Noise resistance	±240 V the square wave noise (pulse width: 1 μs) by the noise simulator	
Dielectric strength	500 VAC 50/60Hz for 1 min. (between external terminals and case, between i/o and power terminals)	
Vibration	1.5 mm amplitude or 300m/s <sup>2</sup> at frequency of 10 to 55 Hz (for 1 min.) in each of X, Y, Z directions for 2 hours	
Shock	500m/s <sup>2</sup> (approx. 50 G) in each of X, Y, Z directions for 3 times	
Environment	Ambient temperature	-10 to 50 °C, storage: -25 to 75 °C
	Ambient humidity	35 to 85%RH, storage: 35 to 85%RH

※Environment resistance is rated at no freezing or condensation.

# DeviceNet Analog Remote I/O

## Specifications

Model	ARD-AI04	ARD-AO04
Protection	IP20(IEC standard)	
Protection circuit	Surge, ESD protection, Reverse polarity protection circuit	
Indicator	Network status(NS) LED(green, red), Unit status(MS) LED(green, red)	
Material	Front case, Body Case: PC	
Mounting	DIN rail or screw lock type	
Approval	CE DeviceNet	
Weight <sup>※1</sup>	Approx. 210 g (approx. 145 g)	

※1. The weight is with packaging and the weight in parentheses is only unit weight.

## DeviceNet communication

Item	Specifications
Communication	I/O Slave messaging(Group 2 Only slave) ● Poll command: Yes ● Bit_strobe command: Yes ● Cyclic command: Yes ● COS command: Yes
Communication distance	Max. 500 m(125kbps), Max. 250 m(250kbps), Max. 100 m(500kbps)
NODE ADDRESS setting	Max. 64 nodes
Communication speed	125 kbps 250 kbps 500 kbps(automatically set when connecting with Master)
Insulation	I/O and inner circuit: Non-insulation, DeviceNetand inner circuit: Insulation, DeviceNet power: Insulation
Approval	ODVA Conformance tested

## Part descriptions

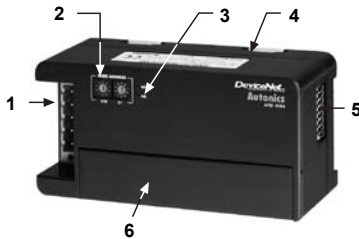

### 1. DeviceNet connector

No.	Color	For	Organization
5	Red	24VDC(+)	
4	White	CAN_H	
3	None	SHIELD	
2	Blue	CAN_L	
1	Black	24VDC(-)	

**2. Rotary switch for node address** : Two rotary switches are used for setting node address.

X10 switch represents the 10's multiplier and X10 switch represents the 1's multiplier.

**3. Status LED** : It is LED for displaying Unit status(MS) and Network status(NS).

**4. Rail Lock** : It is used for mounting DIN rail or with screws.

**5. DIP switch** : It is used for set I/O range. (factory default: all switches are OFF)

(●: ON, -: OFF)



I/O range	ARD-AI04(Input model)						ARD-AO04(output model)						SW7	SW8 <sup>※1</sup>
	CH0, CH1			CH2, CH3			CH0, CH1			CH2, CH3				
0-5 VDC	—	—	—	—	—	—	—	—	—	Not supported	Not supported (Off Setting)	ON Using DIP switch		
1-5 VDC	●	—	—	●	—	—	●	—	—					
0-10 VDC	—	●	—	—	●	—	—	●	—					
-5-5 VDC	●	●	—	●	●	—	●	●	—					
-10-10 VDC	—	—	●	—	—	●	—	—	●					
DC 4-20 mA	●	—	●	●	—	●	Not supported			—	—	—	OFF Not using DIP switch	
DC 0-20 mA	—	●	●	—	●	●	●	—	—	—	—	—		

※1: By turning ON SW8, I/O range is set by DIP switches (SW1 to SW6).

By turning OFF SW8, I/O range is set by communication.

When setting I/O range by DIP switches, CH0 and CH1(CH2 and CH3) cannot be set individually.

When setting it by communication, each channel is set individually.

**6. I/O Terminal block**: It is terminal block for connecting external device I/O.

(A)	Photo electric sensor
(B)	Fiber optic sensor
(C)	Door/Area sensor
(D)	Proximity sensor
(E)	Pressure sensor
(F)	Rotary encoder
(G)	Connector/Socket
(H)	Temp. controller
(I)	SSR/Power controller
(J)	Counter
(K)	Timer
(L)	Panel meter
(M)	Tacho/Speed/Pulse meter
(N)	Display unit
(O)	Sensor controller
(P)	Switching mode power supply
(Q)	Stepper motor& Driver&Controller
(R)	Graphic/Logic panel
(S)	Field network device
(T)	Software
(U)	Other

# ARD-A Series

## ■ Dimensions

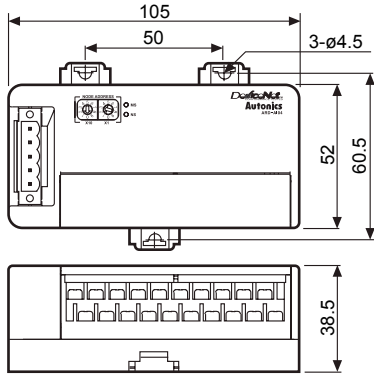

### ● Panel cut-out

(unit : mm)

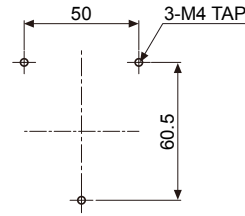

## ■ Connections

### ● ARD-AI04

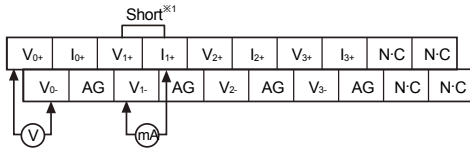

### ● ARD-AO04

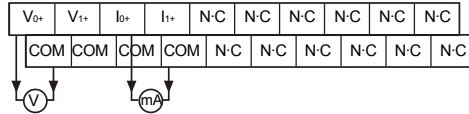

Voltage	0-5 VDC
	1 to 5 VDC
	-5-5 VDC
	0-10 VDC
Current	-10-10 VDC
	DC 0-20 mA
	DC 4-20 mA

※1: For current input, short between  $V_{\square+}$  and  $I_{\square+}$ .

## ■ I/O circuit

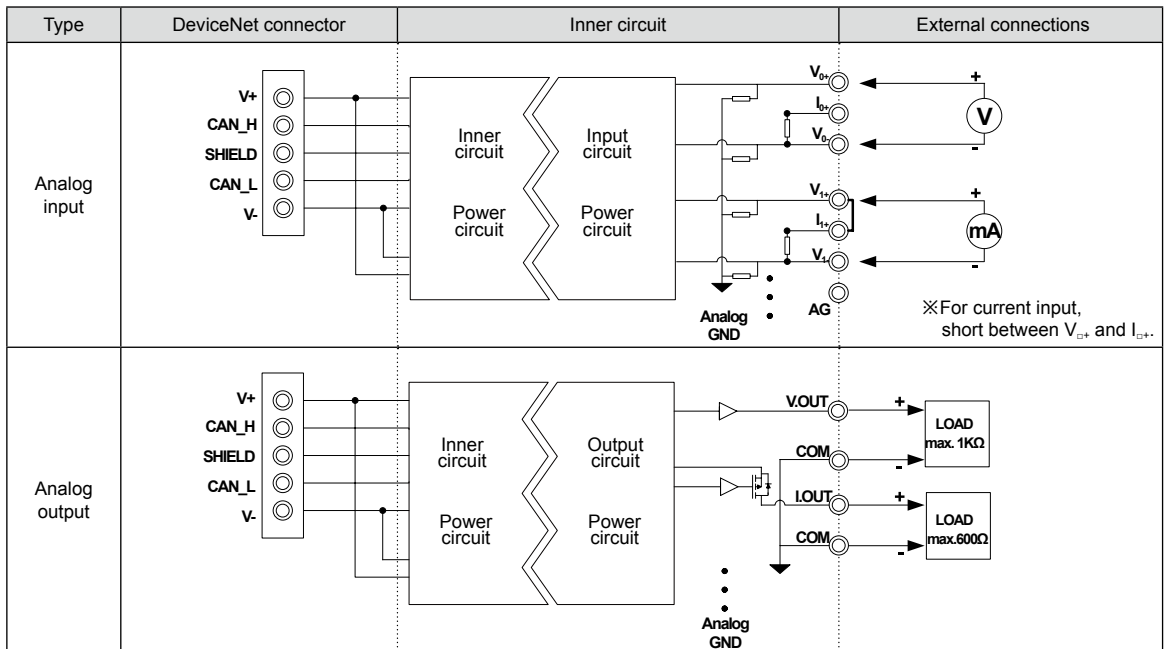

# DeviceNet Analog Remote I/O

## ■ Status LED

※Status of MS LED, NS LED

(: ON, : Flash, : OFF)

No.	Type	LED status	Color	Descriptions	Troubleshooting
1	MS		Green	<b>Normal operation</b> I/O communication or message communication is working.	—
	NS		Green		
2	MS		Green	<b>Standby of duplicated address</b> The status of standby for receiving message of duplicated address check from master unit.	—
	NS		—		
3	MS		Green	<b>Standby of normal operation</b> The status of standby for establish connection from master unit.	—
	NS		Green		
4	MS		Red	<b>Switch setting error</b> The status that DIP switch or another switch setting is invalid.	Change the switch setting to valid value and re-supply the power.
	NS		—		
5	MS		Red	<b>Changed address during normal operation</b> The status that address is changed during normal operation.	Change the initial address at the power applied at first.
	NS		Green		
6	MS		—	<b>Invalid address</b> The status of setting invalid address	Change the valid address and re-supply the power.
	NS		Red		
7	MS		Red	<b>Duplicated address</b> There is duplicated address in the network. <b>Occuring Bus-Off error</b> Communication is stopped with Bus-Off.	Change not-duplicated address.  Re-supply the power to slave units and check master, communication cable, terminating resistance, and noise of network.
	NS		Red		
8	MS		Green	<b>I/O Connection time out</b>	
	NS		Red		

## ■ Setup and installation

### ◎ Node address setup

- Two rotary switches are used for setting node address.  
X10 switch represents the 10's multiplier and X10 switch represents the 1's multiplier.  
Node address is settable from 0 to 63.
- Node address is changed when re-supplying the power to the unit.  
After changing node address, must re-supply the power.

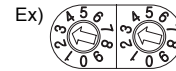

Ex) The X10 and X1 switches point "3", the address is "33".

### ◎ Installation

#### ● Mounting on panel

- Pull Rail Locks(3EA) on the rear part of a unit, there are fixing screw hole.
- Place the unit on a panel to be mounted.
- Make a hole on a fixing screw position.
- Fasten the screw to fix the unit tightly.  
Tightening torque should be below 0.5N.m.

#### ● Mounting on DIN rail

- Pull two Rail Locks on the rear part of unit.
- Place the unit on DIN rail to be mounted.
- Press Rail Locks to fix the unit tightly.

### ◎ I/O cable connection

Refer to the I/O circuit diagram and connections.

Connect a sensor or the signal cable of external I/O device to the terminal block. (tightening torque: 0.5N·m)

### ◎ DeviceNet cable connection

- For stable system, it is recommended to use the DeviceNet dedicated cable.
- Connect the DeviceNet cable to the DeviceNet connector and tighten the fixed screw of the connector by a driver. (tightening torque: 0.5N·m)
- Connect the DeviceNet connector to ARD unit and supply the power to Network.

#### Master unit

PIN No.	Signal
5	V+
4	CAN_H
3	SHIELD
2	CAN_L
1	V-

#### ARD unit

PIN No.	Signal
5	V+
4	CAN_H
3	SHIELD
2	CAN_L
1	V-

Red  
White  
None  
Blue  
Black

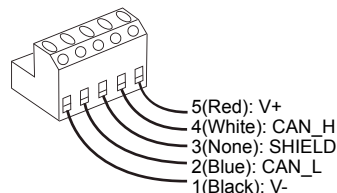

(A) Photo electric sensor

(B) Fiber optic sensor

(C) Door/Area sensor

(D) Proximity sensor

(E) Pressure sensor

(F) Rotary encoder

(G) Connector/Socket

(H) Temp. controller

(I) SSR/Power controller

(J) Counter

(K) Timer

(L) Panel meter

(M) Tacho/Speed/ Pulse meter

(N) Display unit

(O) Sensor controller

(P) Switching mode power supply

(Q) Stepper motor& Driver&Controller

(R) Graphic/Logic panel

(S) Field network device

(T) Software

(U) Other

# ARD-A Series

## ○ Setting of Master unit

① Check the LED status of ARD unit when power is supplied. Normal operation is as below.

Type	Status LED	Status descriptions
Unit status(MS) LED	Green LED is ON	When master unit status is communication standby: NS LED flashes
Network status(NS) LED	Green LED is ON/flashes	When master unit setting is completed: NS LED is ON.

- ② Install the software from master unit manufacturing company.
- ③ Setting communication speed and address in the software.
  - Baud rate: 125/250/500kbps
  - Address of master unit: Usually it is set 00 address.
- ④ Register connected unit on Network to the master unit.
  - There are two ways to register units; automatically register in on-line or manually register in off-line. (Refer to the manual of master unit.)
  - I/O assignment of ARD Series: Usually it is automatically assigned by the setting software.
  - Setting of operation mode: Select among Poll, COS, Cyclic, Bit Strobe.(Usually set Poll mode.)

## ○ Check operating status

When installation and setting are completed, unit status (MS) LED and Network status (NS) LED turns ON in green. (Refer to □ Status LED.)

## ■ Communication distance

Baud Rate	Max. network length	Max. length of branch line	Allowable expansion length of branch line
125kbps	500m	6m	156m
250kbps	250m	6m	78m
500kbps	100m	6m	39m

## ■ Terminating resistance

- 120Ω
- 1%or metallic film
- 1/4W

※Do not install terminating resistance on ARD unit or it may cause network problem (impedance can be too high or low) or malfunction.

※Connect terminating resistance on the both ends of the trunk line.

## ■ Functions

Model	ARD-AI04 (input model)	ARD-AO04 (output model)	
Basic	Com. speed auto-recognition	●	
	Network power voltage monitoring	●	
	Unit power on total time monitoring	●	
	Unit comment	●	
	Last maintenance data stored	●	
	Scaling	●	
Analog	I/O comment	●	
	Adjustment gradient	●	
	Adjustment offset	●	
	Input conversion points setting	●	—
	Input digital filter	●	—
	Peak/Bottom hold	●	—
	Disconnected cable detection	●	—
	Input comparison	●	—
	Hysteresis	●	—
	Output setting for error	—	●

## ○ Network power voltage monitoring

- Network power voltage is lower than the set value, the network power voltage drop flag bit of Status bit is ON. It is able to read by Configurator or Explicit message.
- Set monitoring voltage by Explicit message at Network Power voltage (Set Value) of Application Object.
- Set range: 0 to 255  
(factory default: 12 V, Allowable range: ±1 V)
- ※ Min. supplied power is 12 V for ARD unit.  
If network voltage is lower than 12 V, the contents of Explicit message reading is not guaranteed.

## ○ Unit power on total time monitoring

- When total time for supplying power to the unit becomes the SV, Threshold Run Hours Flag bit of Status Bit turns ON. It is able to read by Configurator or Explicit message.
- Set the time by Explicit message at Threshold Run Hour of Application Object.
- Set range: 0 to 429,496,729 hours  
(factory default: 876,000 hours),  
Measured unit: 0.1 hours(6 minutes)

## ○ Communication speed auto-recognition

It recognizes communication speed when connecting master. Communication speed is able to change only from master unit.

After changing communication speed, re-supply the network power to apply the changed communication speed.

# DeviceNet Analog Remote I/O

## ○ Unit comment

- You can set the comments for the unit (product description) on network. It is able to read by Configurator or Explicit message.
- Set comment by Explicit message at Unit Comment of Application Object.
- Set range: max. 32 characters

## ○ Last maintenance date

- It saves the last date of maintenance. It is able to read/write by Configurator or Explicit message.
- Set maintenance date by Explicit message at I/O Last Maintenance Data Setting of Analog Input Point Object.  
Ex)Data: 0x07DB020E→07DB(2011), 02(Februray), 0E(14th)

## ○ Input conversion points setting

- Conversion cycle is changed by the number of points. (conversion cycle: 1ms/point, when using 4 points, it is 4 ms). It is able to read/write by Configurator or Explicit message. After changing the number of conversion points, re-supply the network power.
- Set the number of conversion points by Explicit message at Number of AD Conversion Points Setting of Analog Input Point Object.
- Set range: 1 to 4-point(factory default: 4-point), conversion cycle: 1 ms/1-point

## ○ Display scale

- Set high/low-limit scale value of analog input or output. It is able to read by Configurator or Explicit message.

Default Scaling	Function Choice : Scaling Flag bit ON Scaling Type : Default Scaling (factory default)	It is set as 1,000 by 1 V(mA). In case of 1-5 V, 4-20 mA, it is applied from over min. allowable range 0.8 V(800), 3.2(3,200). The below input value is break detection. It outputs as min. allowable range.
None Scaling	Function Choice : Scaling Flag bit OFF Scaling Type : Default Scaling	It is set as default value 0 to 16000(-8000 to 8000). ( 0-5 V, 1-5 V, 0-10 V, 4-20 mA, 0-20 mA : 0 to 16000, -5-5 V, -10-10 V : -8,000 to 8,000 )
User Scaling	Function Choice : Scaling Flag bit ON Scaling Type : User Scaling	Set high/low-limit value to apply at 'Scaling Point 0%' and 'Scaling Point 100%'. Set range: -28,000 to 28,000

## ○ I/O comment

- You can set the comment for I/O. It is able to read/write by Configurator or Explicit message.
- Set I/O comment by Explicit message at I/O Comment of Analog Input Point Object, Analog Output Point Object.
- Set range: max. 32 characters

## ○ Gradient adjustment

- It adjusts the gradient of input/output value or scale value. It is able to read/write by Configurator or Explicit message.
- It is applied when Adjust Gradient Flag bit is set as ON at Function Choice of Analog Input Point Object. Set the range at Adjustment Gradient value.
- Adjustment range: -5 to 5%,  
Set range: -500 to 500(factory default: 0)  
Ex)When input value is 1000, Adjustment Gradient is 500(+5%)  $X'=aX$ ,  $a=1+\text{Adjustment Gradient}(0.05)$ ,  $X=1000$ ,  $X'=1.05 \times 1000=1050$

## ○ Offset adjustment

- This function is to adjust the error occurring from external analog sensor, etc, not from the unit itself. It is also applied to analog output. It is able to read/write by Configurator or Explicit message.
- It is applied when Adjustment Offset Flag bit is set as ON at Function Choice of Analog Input Point Object. Set the value at Adjustment Offset Value.
- Adjustment range: -5 to 5%,  
Set range: -500 to 500 (factory default: 0)  
Ex)When input range is 0 to 10V, Full Scale 0 to 16000, input value is 1600(1V) and Adjustment Gradient 500(+5%),  
 $X'=X+b$ ,  $X=1600$ ,  $b=16000 \times 0.05$  (added input value and percentage of Full Scale)  
 $X'=1600+800=2400(1.5V)$

## ○ Input digital filter

- This function is used when input value vibrates or repeatedly shake by included noise at input signal. Accurate control is available by stable input with this function. It adopts moving average filter method not to affect sampling cycle. It is able to read/write by Configurator or Explicit message.
- It is applied when Moving Average is set as ON at Function Choice of Analog Input Point. Set the number of digital filters at Moving Average Filter of Number.
- Set range: 0 to 8 (factory default: 3[Moving Average No\_8])

## ○ Disconnection detection

- When operating analog input cable (voltage/current input) is disconnected, Broken Wire Flag Bit turns ON at Analog Status Flag Read of Analog Input Point Object. (It operates only for 1-5 V, 4-20 mA input range.) It is able to read by Configurator or Explicit message.
- If this value is below -5%, it recognizes disconnection and displays '32767' as data value.

## ○ Hysteresis

- In case of comparison output, this function is to increase stability of comparison output against vibration of input signal or chattering. It is able to read by Configurator or Explicit message.
- It is applied when Compare Bit flag turns ON at Function Choice of Analog Input Point Object. Set the value at Hysteresis Value.
- Set range: 0 to 16,383(factory default: 0)

(A)	Photo electric sensor
(B)	Fiber optic sensor
(C)	Door/Area sensor
(D)	Proximity sensor
(E)	Pressure sensor
(F)	Rotary encoder
(G)	Connector/Socket
(H)	Temp. controller
(I)	SSR/Power controller
(J)	Counter
(K)	Timer
(L)	Panel meter
(M)	Tacho/Speed/ Pulse meter
(N)	Display unit
(O)	Sensor controller
(P)	Switching mode power supply
(Q)	Stepper motor& Driver&Controller
(R)	Graphic/Logic panel
(S)	Field network device
(T)	Software
(U)	Other

## ○ Input min./max. value save

### ● Min./Max. save when power is ON

It saves min./max. input value from power ON the network. (When network power is OFF, the saved min./max. input value are cleared.)

It is able to read by Configurator or Explicit message. When Clear Max, Clear Min Flag bit of is ON at Function Choice of Analog Output Point Object, the saved values are cleared and it saves current min./max. value of current input.

### ● Min./Max. save when Peak/Bottom Hold signal is ON

It memorizes the max./min. value while Peak/Bottom hold signal is ON. When Peak/Bottom signal is OFF, they are saved.

It is able to read by Configurator or Explicit message. It is applied when Peak/Bottom is set as ON at Function Choice of Analog Input Point Object. You can check the value of Peak/Bottom at Peak Value and Bottom Value.

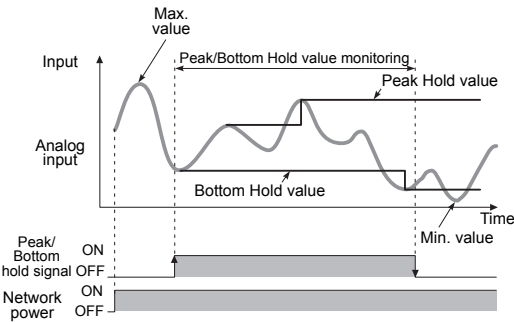

## ○ Input comparison

- It compares analog input value or the operation value and alarm set value (HH, H, L, LL) and Analog Status Bit flag turns ON at Function Choice of Analog Input Point Object. It is able to read by Configurator or Explicit message.
- If the value is within the set range between 'H' and 'L', it is available to apply by turning ON Pass Signal Flag bit at Analog Status Flag Read of Analog Input Point Object and turning ON/OFF Comparator Flag bit at Function Choice.

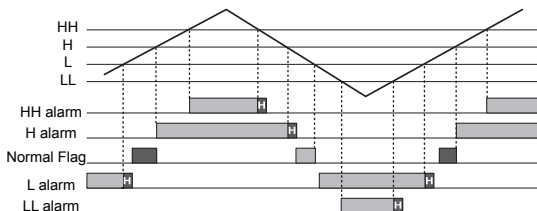

## ○ Output value setting for com. error

- When communication error occurs, this function is to set output value of output unit by each channel. It is able to read by Configurator or Explicit message.
- Set Fault state at Fault Action of Analog Output Point.
- Set range: 0 to 3(factory default: 1)
  - 0: Hold Last State-maintains the last status
  - 2: High Limit-outputs max. value
  - 1: Low Limit-outputs min. value
  - 3: Zero Count-outputs 0%

## ○ Status flag monitoring

- When the network power voltage is lower than the set value or unit operation time is over the set value, monitoring is available by Status Bit of Application Object.

It is able to read by Configurator or Explicit message.

### ※ Flag Bit

- Bit 0: Reserved
- Bit 1: Network Power Voltage Drops (below the set level)
- Bit 2: Life State(Unit)
- Bit 3: Reserved
- Bit 4: Reserved
- Bit 5: Reserved
- Bit 6: Reserved
- Bit 7: Reserved

## ○ Analog data allotment

- This function is to allot analog data. Select the desired data to transmit it to the master unit. It is able to read by Configurator or Explicit message.
- Set the allotment at Analog Data 1/2 Allocation selection of Analog Output Point.
- Set range: 0 to 2(factory default: 0)
  - 0: Analog Input Value
  - 1: Peak Value
  - 2: Bottom Value

## ■ I/O range

### Analog I/O specifications (ARD-AI04, ARD-AO04)

No.	I/O range	Max. allowable I/O range
0	0-5 VDC	-0.25-5.25 VDC
1	1-5 VDC	0.8-5.2 VDC
2	0-10 VDC	-0.5-10.5 VDC
3	-5-5 VDC	-5.5-5.5 VDC
4	-10-10 VDC	-11-11 VDC
5	DC 4-20 mA	DC 3.2-20.8 mA
6	DC 0-20 mA	DC 0-21 mA

# DeviceNet Analog Remote I/O

## ■ Assembly Instance ID assignment

### ◎ Produced I/O assignment(Input)

It is available to assign I/O data by the selected data at master. When changing Produced I/O data assignment, re-supply the network power of ARD unit to apply the changed assignment.

#### 1)Analog Data1(Default I/O Data)

Analog Data 1 is assigned as Produced I/O data by Configurator or Explicit message. By property setting, assignment is available as Analog Input Value, Peak Value, Bottom Value.

- Assembly Instance ID: 103, ● Default: 0
- Set range: 0 to 2 (Analog Input Value: 0, Peak Value: 1, Bottom Value: 2)
- Data type: Word, Data size: 4Word

15	0	15	0
Assigned value to Analog Data 1 of Input point 0		Assigned value to Analog Data 1 of Input point 2	
Assigned value to Analog Data 1 of Input point 1		Assigned value to Analog Data 1 of Input point 3	

#### 2)Analog Data2

Analog Data 2 is assigned as Produced I/O data by Configurator or Explicit message. By property setting, assignment is available as Analog Input Value, Peak Value, Bottom Value.

- Assembly Instance ID: 104, ● Default: 0
- Set range: 0 to 2(Analog Input Value: 0, Peak Value: 1, Bottom Value: 2)
- Data type: Word, Data size: 4Word

15	0	15	0
Assigned value to Analog Data 2 of Input point 0		Assigned value to Analog Data 2 of Input point 2	
Assigned value to Analog Data 2 of Input point 1		Assigned value to Analog Data 2 of Input point 3	

#### 3)Generic Status

Generic Status is assigned as Produced I/O data by Configurator or Explicit message.

- Assembly Instance ID: 100, ● Data type: Byte, Data size: 1Byte
- Generic Status

Bit 0: Reserved.	Bit 3: Reserved.	Bit 6: Reserved.
Bit 1: Network Power Voltage Drops.	Bit 4: Reserved.	Bit 7: Reserved.
Bit 2: Life State(Unit)	Bit 5: Reserved.	

15	0
—	Generic Status

#### 4)Analog Status

Analog Status is assigned as Produced I/O data by Configurator or Explicit message.

- Assembly Instance ID: 105, ●Data type: Byte, Data size: 4Byte
- Analog Status

Bit 0: Low Alarm(LL)	Bit 3: High Warning(H)	Bit 6: Under Range
Bit 1: Low Warning(L)	Bit 4: High Alarm(HH)	Bit 7: Over Range
Bit 2: Pass Signal(Nomal)	Bit 5: Broken Wire	

15	0		
Analog Status of Input point 1		Analog Status of Input point 0	
Analog Status of Input point 3		Analog Status of Input point 2	

#### 5)Analog Data1+Analog Data2

Analog Data 1 + Analog Data 2 is assigned as Produced I/O data by Configurator or Explicit message. By property setting, assignment is available as Analog Input Value, Peak Value, Bottom Value.

- Assembly Instance ID: 106, ● Default: 0
- Set range: 0 to 2(Analog Input Value: 0, Peak Value: 1, Bottom Value: 2)
- Data type: Word, Data size: 8Word

15	0	15	0
Assigned value to Analog Data 1 of Input point 0		Assigned value to Analog Data 1 of Input point 2	
Assigned value to Analog Data 2 of Input point 0		Assigned value to Analog Data 2 of Input point 2	
Assigned value to Analog Data 1 of Input point 1		Assigned value to Analog Data 1 of Input point 3	
Assigned value to Analog Data 2 of Input point 1		Assigned value to Analog Data 2 of Input point 3	

#### 6)Analog Status+Generic Status

Analog Status + Generic Status is assigned as Produced I/O data by Configurator or Explicit message.

- Assembly Instance ID: 107, ● Data type: Byte, Data size: 5Byte

15	0		
Analog Status of Input point 1		Analog Status of Input point 0	
Analog Status of Input point 3		Analog Status of Input point 2	
—		Generic Status	

(A)	Photo electric sensor
(B)	Fiber optic sensor
(C)	Door/Area sensor
(D)	Proximity sensor
(E)	Pressure sensor
(F)	Rotary encoder
(G)	Connector/ Socket
(H)	Temp. controller
(I)	SSR/ Power controller
(J)	Counter
(K)	Timer
(L)	Panel meter
(M)	Tacho/ Speed/ Pulse meter
(N)	Display unit
(O)	Sensor controller
(P)	Switching mode power supply
(Q)	Stepper motor& Driver&Controller
(R)	Graphic/ Logic panel
(S)	Field network device
(T)	Software
(U)	Other



# ARD-A Series

## 7)Analog Data+Analog Status

Analog Data 1 + Analog Status is assigned as Produced I/O data by Configurator or Explicit message. By property setting, assignment is available as Analog Input Value, Peak Value, Bottom Value.

- Assembly Instance ID: 108                                      ● Default: 0
- Set range: 0 to 2(Analog Input Value: 0, Peak Value: 1, Bottom Value: 2
- Data type: Byte, Data size: 12Byte

15

0

Assigned value to Analog Data 1 of Input point 0	
Assigned Low Byte at Analog Data 1 of Input point 1	Analog Status of Input point 0
Analog Status of Input point 1	Assigned High Byte at Analog Data 1 of Input point 1
Assigned value to Analog Data 1 of Input point 2	
Assigned Low Byte at Analog Data 1 of Input point 3	Analog Status of Input point 2
Analog Status of Input point 3	Assigned High Byte at Analog Data 1 of Input point 3

## ■ DeviceNet Explicit Message

### ○ Explicit message format

#### 1)Request(Master→Slave)

##### ●CAN ID Field

Bit11	Bit10	Bit9	Bit8	Bit7	Bit6	Bit5	Bit4	Bit3	Bit2	Bit1	Bit0
1	0	0	0	0	0	0	1	1	1	0	0
Group2		Destination MAC ID						Message ID			

##### ●Data Field

0x40	0x0E	0x01	0x01	0x01	xx	xx	xx
Source Mac ID	Service Code	Class ID	Instance ID	Attribute ID	Data		
					Low	High	Low

#### 2)Response(Slave→Master)

##### ●CAN ID Field

Bit11	Bit10	Bit9	Bit8	Bit7	Bit6	Bit5	Bit4	Bit3	Bit2	Bit1	Bit0
1	0	0	0	0	0	0	1	1	0	1	1
Group2		Source MAC ID						Message ID			

##### ●Data Field

0x40	0x8E	0x21	0x03	xx	xx	xx	xx
Destination MAC ID	Service Code	Data					
		Low	High	Low	High	Low	High

##### ●Error

0x40	0x94	0x14	0xFF	xx	xx	xx	xx
Destination MAC ID	Service Code	Data					
		Low	High	Low	High	Low	High

#### 3)Class ID

Class ID	Object Name
0x01	Identity Object
0x02	Message Router
0x03	DeviceNet Object
0x04	Assembly Object
0x05	DeviceNet Connection Object
0x0A	Analog Input Object
0x0B	Analog Output Object
0x64	Application Object

#### 4)Message ID

Message ID	Message Name
0	Slave's I/O Bit-Strobe Command Message
1	Reserved for Master's Use-Use is TBD
2	Master's change of state or Cyclic Acknowledge Message
3	Slave's Explicit Request Message
4	Master's Explicit Request Message
5	Master's I/O Poll Command/Change of State/Cyclic Message
6	Group2 only unconnected Explicit Request Message
7	Duplicate MAC ID Check Message

# DeviceNet Analog Remote I/O

## 5)Error Code

Error Code	Error Name	Descriptions
0x08	Service not support	Invalid service code
0x09	Invalid Attribute value	Not support the specified attribute value
0x16	Object does not exist	Not support the specified instant ID
0x15	Too much data	Bigger data than the specified size
0x13	Not enough data	Smaller data than the specified size
0x0C	Object state conflict	Not execute the specified instruction when inner error occurs
0x20	Invalid parameter	Not support the specified operation instruction data
0x0E	Attribute not settable	Not support the write about Attribute ID
0x10	Device state conflict	Not execute the specified instruction when inner error occurs
0x14	Attribute not supported	Not support the specified attribute
0x19	Store operation failure	Not save the data in memory
0x2A	Group 2 only server general failure	Not support the specified instruction or attribute or not set attribute

## ◎ Application Object(0x64)

Explicit message	Function	Command			Range	Default
		Service code	Instance ID	Attribute ID		
Status Bit	Flag Bit Bit0:Reserved Bit1:Network Power Voltage Drops Bit2:Threshold Run Hours Bit3:Reserved Bit4:Reserved Bit5:Reserved Bit6:Reserved Bit7:Reserved	Get	1	0x65	—	—
Network Power Voltage (Present Value)	Network power voltage PV	Get	1	0x66	—	—
Network Power Voltage (Top Value)	Network power voltage max. value	Get	1	0x67	—	—
Network Power Voltage (Bottom Value)	Network power voltage min. value	Get	1	0x68	—	—
Network Power Voltage (Set Value)	Network power voltage SV	Get/Set	1	0x69	0 to 255	12
Unit Power ON Total time (Present Value)	Unit operation time	Get	1	0x6A	0 to 429,496,729	—
Threshold Run Hour	Unit operation time SV	Get/Set	1	0x6B	0 to 429,496,729	876,000
Last Maintenance Data Setting	Last maintenance date of unit	Get/Set	1	0x70	—	—
Unit Comment	Unit comment	Get/Set	1	0x6E	—	—
Dip Switch Status	Read Dip Switch status	Get	1	0x72	—	—
Produced I/O	Set input assembly instance 0: Disable 1: Analog Data1 2: Analog Data2 3: Generic Status 4: Analog Status 5: Analog Data1+Analog Data2 6: Analog Status+Generic Status 7: Analog Data1+Analog Status	Get/Set	1	0x73	0 to 7	Input: 1

(A) Photo electric sensor

(B) Fiber optic sensor

(C) Door/Area sensor

(D) Proximity sensor

(E) Pressure sensor

(F) Rotary encoder

(G) Connector/Socket

(H) Temp. controller

(I) SSR/ Power controller

(J) Counter

(K) Timer

(L) Panel meter

(M) Tacho/ Speed/ Pulse meter

(N) Display unit

(O) Sensor controller

(P) Switching mode power supply

(Q) Stepper motor& Driver&Controller

(R) Graphic/ Logic panel

(S) Field network device

(T) Software

(U) Other

# ARD-A Series

## ○ Analog Input Point Object(0x0A)

Attribute Name	Function	Command			Range	Default
		Service code	Instance ID	Attribute ID		
Analog Data1 Value	Analog1 input value read	Get	1 to 4	0x03	—	—
Input Range Setting	Input range setting 0: -10 to 10V      1: 0 to 5V 2: 0 to 10V        3: 4 to 20mA 4: Reserved        5: Reserved 6: -5 to 5V        7: 1 to 5V 8: 0 to 20mA	Get/Set	1 to 4	0x07	0 to 8	2
Number of AD Conversion Points Setting	Number of A/D conversion points read	Get/Set	1	0x64	1 to 4	4
Analog Data2 Value	Analog2 input value read	Get	1 to 4	0x65	—	—
Analog Status Flag Read	Analog Status Flag Bit 0: Low Alarm(LL) Bit 1: Low Warning(L) Bit 2: Pass Signal Bit 3: High Warning(H) Bit 4: High Alarm(HH) Bit 5: Broken Wire Bit 6: Under Range Bit 7: Over Range	Get	1 to 4	0x66	0 to 255	—
Analog Data1 Allocation Selection	Analog Data1 assignment 0: Analog Input Value, 1: Peak Value, 2: Bottom Value	Get/Set	1 to 4	0x67	0 to 2	0
Analog Data2 Allocation Selection	Analog Data2 assignment 0: Analog Input Value, 1: Peak Value, 2: Bottom Value	Get/Set	1 to 4	0x68	0 to 2	0
Function Choice	Function setting Bit 0: Moving Average Bit 1: Scaling Bit 2: Peak/Bottom Bit 3: Comparator Bit 4: Adjustment Offset Bit 5: Adjustment Gradient Bit 6: Clear Max Bit 7: Clear Min	Get/Set	1 to 4	0x69	—	Bit0 Bit1
Scaling Type Setting	0: Default Scaling 1: User Scaling	Get/Set	1 to 4	0x6A	0 to 1	0
Scaling Point 0% Setting	Low-limit scale value setting	Get/Set	1 to 4	0x6B	-28,000 to 28,000	0
Scaling Point 100% Setting	High-limit scale value setting	Get/Set	1 to 4	0x6C	-28,000 to 28,000	16,000
Adjustment Offset Value	Offset adjustment value setting	Get/Set	1 to 4	0x6D	-500 to 500	0
Max Value	Max. input value	Get	1 to 4	0x6E	-32,768 to 32,767	0
Min Value	Min. input value	Get	1 to 4	0x6F	-32,768 to 32,767	0
Peak Value	Input peak value	Get	1 to 4	0x70	-32,768 to 32,767	0
Bottom Value	Input bottom value	Get	1 to 4	0x71	-32,768 to 32,767	0
Hysteresis Value	Hysteresis SV for comparison	Get/Set	1 to 4	0x72	0 to 16,383	0
Alarm Trip Point High(HH)	HH Alarm SV	Get/Set	1 to 4	0x73	-32,768 to 32,767	0
Warning Trip Point High(H)	H warning SV	Get/Set	1 to 4	0x74	-32,768 to 32,767	0
Warning Trip Point(L)	L warning SV	Get/Set	1 to 4	0x75	-32,768 to 32,767	0
Alarm Trip Point Low(LL)	LL Alarm SV	Get/Set	1 to 4	0x76	-32,768 to 32,767	0
Adjustment Gradient Value	Fixed gradient value setting	Get/Set	1 to 4	0x78	-500 to 500	0
Moving Average Filter of Number	Number of digital filter setting 0: Disable, 1: No_2 2: No_4, 3: No_8 4: No_16, 5: No_32 6: No_64, 7: No_128 8: No_256	Get/Set	1 to 4	0x79	0 to 8	3
I/O Last Maintenance Data Setting	Last maintenance date of I/O	Get/Set	1 to 4	0x7A	—	—
I/O Comment	I/O input comment	Get/Set	1 to 4	0x7B	—	—

# DeviceNet Analog Remote I/O

## ○ Analog Output Point Object(0x0B)

Explicit message	Function	Command			Range	Default
		Service code	Instance ID	Attribute ID		
Analog Output Value	Analog output value	Get	1 to 2	0x03	—	—
Output Range Setting	Output range setting 0: -10 to 10V      1: 0 to 5V 2: 0 to 10V        3: 4 to 20mA 6: -5 to 5V        7: 1 to 5V 8: 0 to 20mA	Get/Set	1 to 2	0x07	0 to 8	2
Fault Action	Fault State 0: Hold Last State 1: Low Limit 2: High Limit 3: Zero Count	Get/Set	1 to 2	0x09	0 to 3	1
Function Choice	Function setting Bit0: Reserved Bit1: Scaling Bit2: Reserved Bit3: Reserved Bit4: Adjustment Offset Bit5: Adjustment Gradient Bit6: Reserved Bit7: Reserved	Get	1 to 2	0x69	—	Bit1
Scaling Type Setting	0: Default Scaling 1: User Scaling	Get	1 to 2	0x6A	0 to 1	0
Scaling Point 0% Setting	Low-limit scale value setting	Get/Set	1 to 2	0x6B	-28,000 to 28,000	0
Scaling Point 100% Setting	High-limit scale value setting	Get/Set	1 to 2	0x6C	-28,000 to 28,000	16,000
Adjustment Offset Value	Offset adjustment value setting	Get/Set	1 to 2	0x6D	-500 to 500	0
Adjustment Gradient Value	Fixed gradient value setting	Get/Set	1 to 2	0x78	-500 to 500	0
I/O Last Maintenance Data Setting	Last maintenance date of I/O	Get/Set	1 to 2	0x7A	—	—
I/O Comment	I/O output comment	Get/Set	1 to 2	0x7B	—	—

## ■ Caution for using

- Node addresses of connected units should not be duplicated. If you change node address during operation, the Unit status(MS) flashes in red and it communicates with the previous node address. Re-supply the power and the changed node address is applied.
- Communication speed which is set on Master is set automatically. If you change communication speed during operation, the Network status(NS) LED turns ON in red and it does not communicate. Re-supply the power and it operates normally.
- Make sure to use the communication cables, and taps which are DeviceNet standards. It may cause communication error if non-standard products are used.
- Make sure to examine disconnection or short-circuit before connecting cables.
- Do not install the unit where severe dust exists or where corrosion may occur.
- Installation environment
  - It shall be used indoor.
  - Altitude max. 2,000m
  - Pollution degree 2
  - Installation category II

(A) Photo electric sensor
(B) Fiber optic sensor
(C) Door/Area sensor
(D) Proximity sensor
(E) Pressure sensor
(F) Rotary encoder
(G) Connector/Socket
(H) Temp. controller
(I) SSR/ Power controller
(J) Counter
(K) Timer
(L) Panel meter
(M) Tacho/ Speed/ Pulse meter
(N) Display unit
(O) Sensor controller
(P) Switching mode power supply
(Q) Stepper motor& Driver&Controller
(R) Graphic/ Logic panel
(S) Field network device
(T) Software
(U) Other