

VISOR® V10 object sensor

Advanced vision sensor for object detection, 6 mm

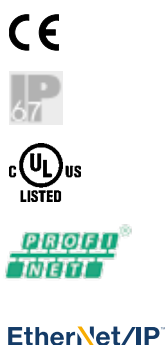

PRODUCT HIGHLIGHTS

- User-friendly configuration and viewer software with hierarchical user rights
- Detectors for object detection
- Real-world engineering units and robot coordinates at a mouse click
- Precise position determination: X/Y-position and orientation
- Comprehensive logic functions for digital switching outputs
- Encoder input

Optical data		Functions	
Resolution	736 x 480 pixels	Number of jobs / detectors	max. 255 / max. 255
CMOS	1/3", monochrome	Detectors	Contour, pattern comparison, calliper, BLOB, contrast, brightness, grey level
Integrated lens, focal length	6 mm, adjustable focal position	Properties	Position tracking: X/Y and orientation; pattern comparison / contour: teach-in and detection of patterns and contours; calliper: distance between edges; BLOB; grey threshold, brightness: evaluation of brightness; contrast: evaluation of contrast
Adjustment range	6 mm to infinity	Typical cycle times	Typ. 20 ms pattern comparison Typ. 30 ms contour Typ. 8 ms calliper Typ. 30 ms BLOB Typ. 2 ms brightness Typ. 2 ms contrast Typ. 2 ms grey threshold
Integrated illumination	White, red, infrared LEDs		
Minimum field of view, X x Y	5 x 4 mm ²		
Electrical data		Mechanical data	
Operating voltage, +U _B	18 ... 26.4V DC ¹	Dimensions	65 x 45 x 45 mm (without plug)
Current consumption (without illumination and I/O)	≤ 120 mA	Enclosure rating	IP 67
Current consumption (without I/O)	≤ 200 mA	Material, housing	Aluminium, plastic
Protective circuits	Reverse-polarity protection, U _B / short-circuit protection of all outputs	Material, front screen	Plastic
Power On Delay	Ca. 13 s after Power on	Ambient temperature: operation	0 ... +50 °C ²
Outputs	PNP / NPN (switchable)	Ambient temperature: storage	-20 ... +60 °C ²
Max. output current (per output)	50 mA, 100 mA (pin 12)	Weight	Ca. 160 g
Inputs	PNP/NPN High > U _B -1V, Low < 3V	Plug connections	Supply and I/O M12, 12-pin Ethernet M12, 4-pin Data M12, 5-pin
Input resistance	> 20 kOhm	Vibration and impact resistance	EN 60947-5-2
Encoder input	High > 4V		
Interfaces	Ethernet (LAN), RS422, RS232, EtherNet/IP, PROFINET, SensoWeb		
Inputs/outputs	2 inputs, 4 outputs, 4 selectable inputs/outputs		

¹ Max. ripple < 5V_{SS} ² 80 % air humidity, non-condensing

Illumination	Depth of field	Part number	Article number
White	Normal	V10-OB-A1-W6	535-91001
White	Enhanced	V10-OB-A1-W6D	535-91013
Red	Normal	V10-OB-A1-R6	535-91003
Red	Enhanced	V10-OB-A1-R6D	535-91016
Infrared	Normal	V10-OB-A1-I6	535-91006
Infrared	Enhanced	V10-OB-A1-I6D	535-91019

VISOR® vision sensor

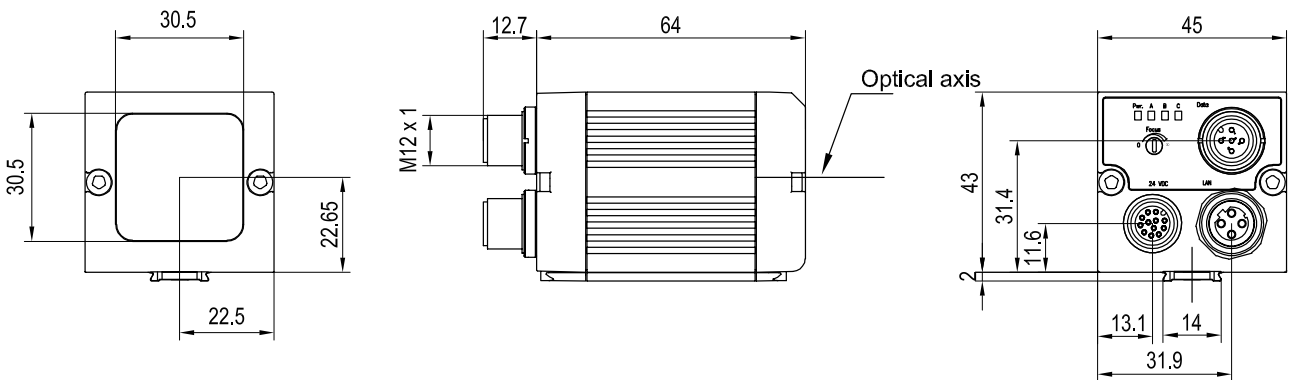

153-00911

4

Field of view

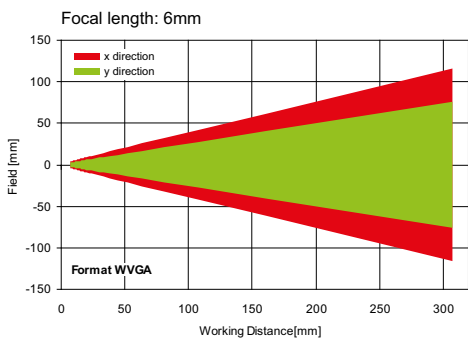

155-01422

Depth of field: normal

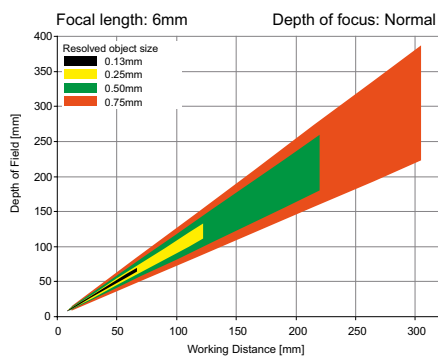

155-01409

Depth of field: enhanced

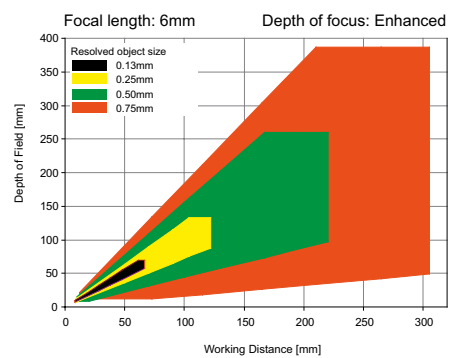

155-01421

Accessories

Connection cables	From Page A-38
Illumination	From Page A-30
Brackets	From Page A-14
Interface accessories	From Page A-42